

Bill of Materials for StudioHub+ A_D Matchjack REVB.sch on Wed Jun 21 02:15:00 2006

Item	Qty	Reference	Value	Manufacturer	Description	Part Number
1	1	C3	.01UF	PANASONIC	SURFACE MOUNT CAPACITOR 0.048 X 0.079 INCHES	ECJ-2VB1H103K
2	10	C7 C10-12 C14 C24-25 C27 C29 C38	.1UF	PANASONIC	SURFACE MOUNT CAPACITOR 0.048 X 0.079 INCHES	ECJ-2YB1H104K
3	8	C22-23 C31-32 C35-36 C40-41	1000PF	PANASONIC	SURFACE MOUNT CAPACITOR 0.048 X 0.079 INCHES	ECJ-2VC1H102J
4	4	C28 C30 C37 C39	33PF	PANASONIC	SURFACE MOUNT CAPACITOR 0.048 X 0.079 INCHES	ECJ-2VC1H330J
5	2	C18-19	.0033 UF	PANASONIC	SURFACE MOUNT CAPACITOR 0.062 X 0.126 INCHES	ECH-U1H332JB5
6	2	C15-16	.012 UF	PANASONIC	SURFACE MOUNT CAPACITOR 0.062 X 0.126 INCHES	ECW-U1H123JB5
7	2	J4-5		DGS DELTRON	RIGHT ANGLE PC MOUNT RCA JACK GOLD	161-4217
8	2	J2-3		STEWART	CONNECTOR RJ45 HORIZ	
9	2	C33-34	22UF	PANASONIC	CAP SURFACE MOUNT NON POLAR VS-D	ECE-V1CA220NP
10	6	C6 C13 C17 C20-21 C26	10UF	PANASONIC	CAP SURFACE MOUNT POLAR VS-B	EEV-FK1V100UR
11	2	C8-9	1UF	PANASONIC	CAP SURFACE MOUNT POLAR VS-B	EEV-FC1V1R0R
12	4	C1-2 C4-5	47UF	PANASONIC	CAP SURFACE MOUNT POLAR VS-D	EEV-FK1E470P
13	4	D5-8	BAS85	VISHAY	Diodes	BAS85
14	4	D2 D4 D9-10	DL4005	Incorporated ON	Diode DL-41	DL4005
15	1	D3	MMSZ5252B	SEMICONDUCTOR TEXAS INSTRUMENTS		MMSZ5252BT1
16	1	U3	DIT4096	TEXAS INSTRUMENTS	DIGITAL AUDIO INTERFACE TRANSMITTER	DIT4096IPW
17	2	JU7-8		SAMTEC	2 PIN HEADER .1 SPACING	TSM-102-01-T-SV
18	6	JU1-6		AMP	3 POSITION .1 HEADER SURFACE MOUNT	146132-1
19	1	D1			LIGHT EMITTING DIODE	
20	1	U1	LM340S-5.0	NATIONAL SEMI	POS VOLT REG	LM340S-5.0
21	1	U2		MICREL	200MA LDO LINEAR REGULATOR	MIC5201-3.3BS
22	1	J1		MOLEX	Header 3 pin with positive latch	70555-0002
23	1	U5	NE5532	TEXAS INSTRUMENTS	Lo Noise Dual Op Amp 8 Pin SMD	NE5532D
24	1	U4	PCM1803A	TEXAS INSTRUMENTS	A/D CONVERTER 24 BIT	PCM1803ADBR
25	2	R25 R28	1.0K	YAEGO	SURFACE MOUNT RESISTOR 0.048 X 0.079 INCHES	RC0805FR (1.0k)
26	2	R21 R24	10.5K	YAEGO	SURFACE MOUNT RESISTOR 0.048 X 0.079 INCHES	RC0805FR (10.5k)
27	2	R4-5	100	YAEGO	SURFACE MOUNT RESISTOR 0.048 X 0.079 INCHES	RC0805FR (100)
28	1	R18	110	YAEGO	SURFACE MOUNT RESISTOR 0.048 X 0.079 INCHES	RC0805FR (110)
29	4	R6-9	143	YAEGO	SURFACE MOUNT RESISTOR 0.048 X 0.079 INCHES	RC0805FR (143)
30	6	R2-3 R19-20 R26-27	20.0K	YAEGO	SURFACE MOUNT RESISTOR 0.048 X 0.079 INCHES	RC0805FR (20.0k)
31	1	R1	422	YAEGO	SURFACE MOUNT RESISTOR 0.048 X 0.079 INCHES	RC0805FR (422)
32	2	R14-15	649	YAEGO	SURFACE MOUNT RESISTOR 0.048 X 0.079 INCHES	RC0805FR (649)
33	4	R16-17 R22-23	8.20K	YAEGO	SURFACE MOUNT RESISTOR 0.048 X 0.079 INCHES	RC0805FR (8.20k)
34	2	R11-12	887	YAEGO	SURFACE MOUNT RESISTOR 0.048 X 0.079 INCHES	RC0805FR (887)
35	1	T1		XFMR5 INC. www.xfmrs.com	TRANSFORMER AES/EBU 1:1 SMD	XF0033AT-00S
36	1	Y1	32/44.1/48	CARDINAL	CMOS PROGRAMMABLE LOW OSCILLATOR with OUTPUT ENABLE	CPPL C 4 L Z - A5 B6 xx.xxxx TS

Analog to Digital MatchJack Specifications

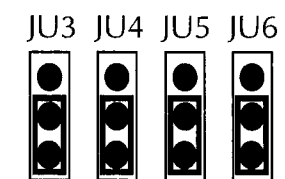
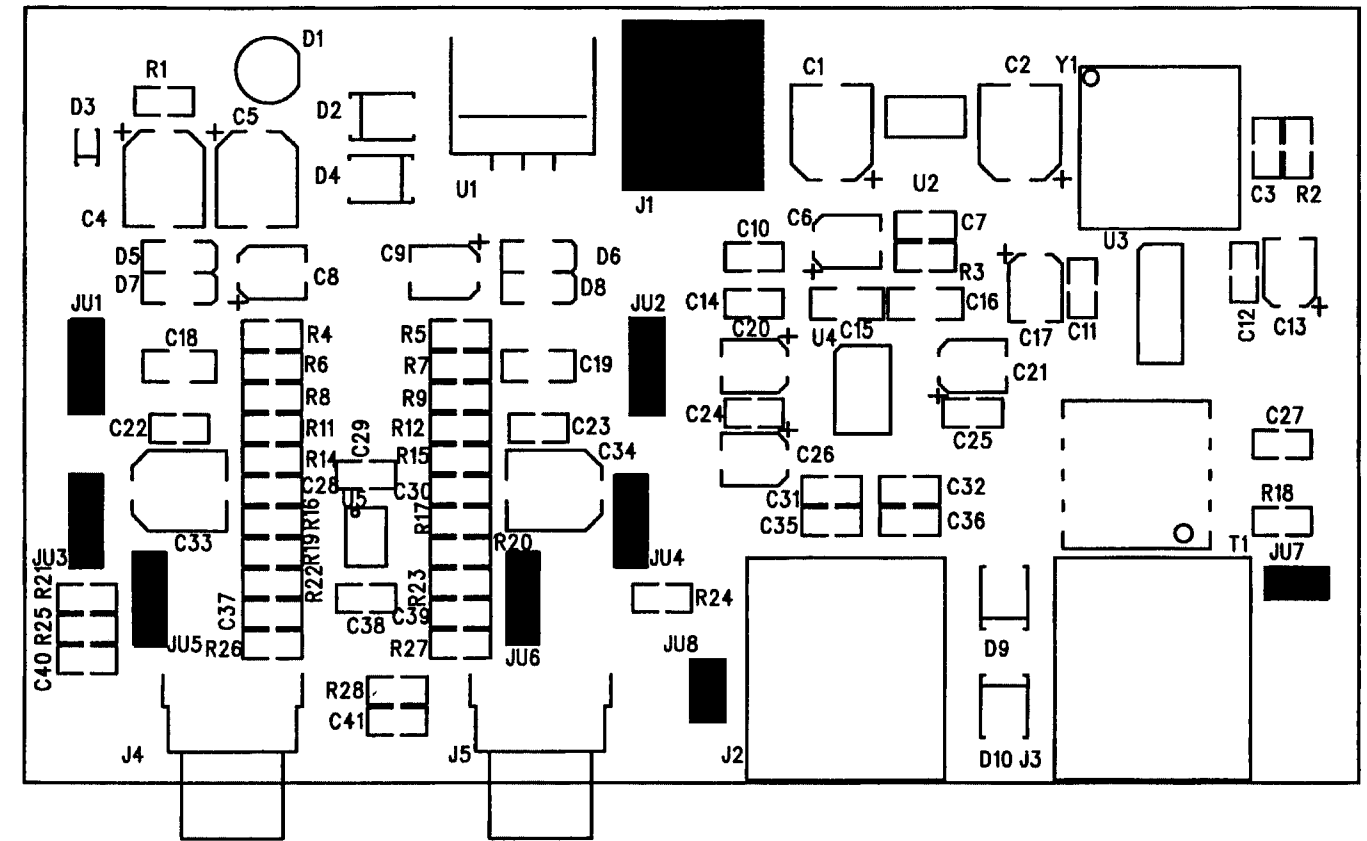

Short lower pins on all jumpers for Pro Input Level

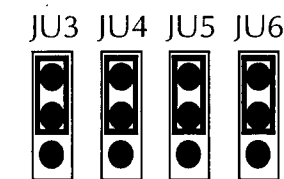

Short upper pins on all jumpers for Consumer (IHF) Input Level

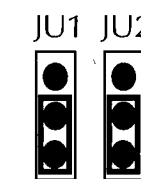

Short lower pins on all jumpers for +4 dB in, -20 dBfs Out

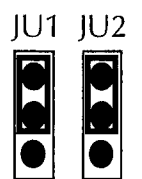

Short upper pins on all jumpers for +0 dB in, -20 dBfs Out

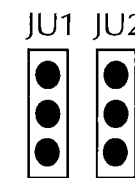

No jumpers for +8 dB in, -20 dBfs Out

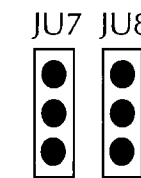

No jumpers to float RJ-45 shield to Ground

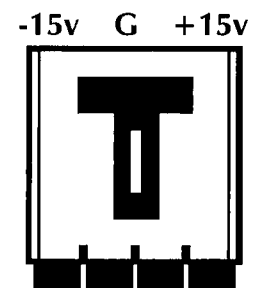

J1 Power Connector

SH+ Analog to Digital Matchjack
RS Part #MJ-AD



REVISION RECORD			
LTR	ECO NO.	APPROVED:	DATE:

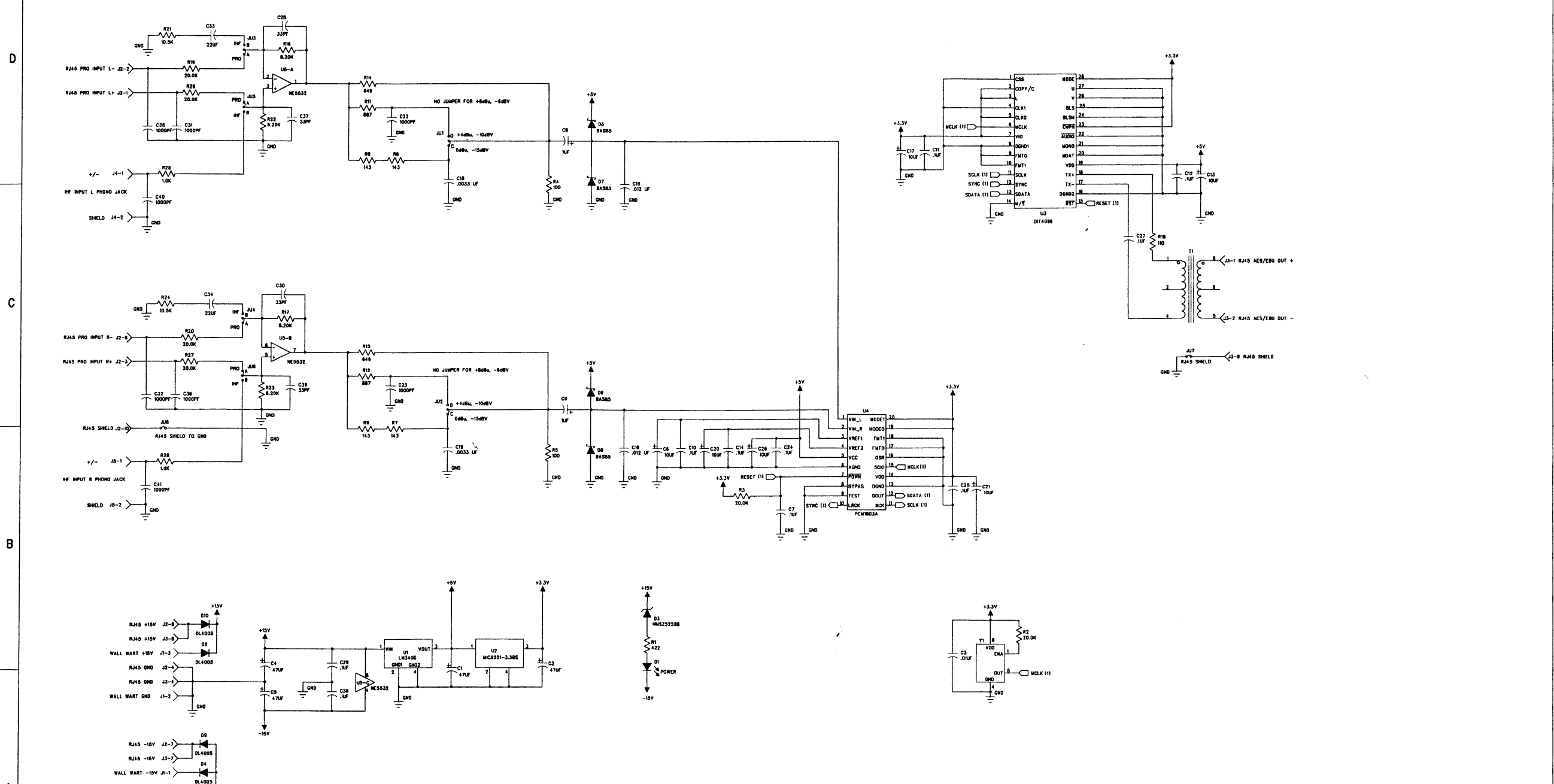

COMPANY:		RADIO SYSTEMS INC. LOGAN TOWNSHIP, NJ	
TITLE:		STUDIOHUB+ A/D MATCHJACK	
DRAWN:	SRWS	DATE:	10-18-2005
CHECKED:		DATE:	
QUALITY CONTROL:		DATE:	
RELEASED:		DATE:	
CODE:	SIZE:	DRAWING NO.:	REV.:
	D	BLANK BOARD 127938 ASSEMBLY 33 142 127948 ASSEMBLY 44.1 142 127958 ASSEMBLY 48 142 127968 ASSEMBLY 96 142 127978	
SCALE: NONE		SHEET: 1 OF 1	